



Application of 3M™ DI-NOC™ Architectural Finishes

A Guide for Interior and Exterior Dry Applications

3M™ DI-NOC™ Architectural Finishes are designed for interior/exterior decoration of high class decorative walls, ceilings, elevators, doors, outside furniture, glass, wet areas (kitchens, bath rooms, laundries etc.). The application of 3M DI-NOC is very simple, leading to a superb finish. Thanks to the Comply™ adhesive feature, air bubbles escape during application. Excellent adhesion and flexibility allows application to many complex curved substrates and for refurbishments.

Typical 3M DI-NOC Applications

- For walls, ceilings, entrance halls, passage ways, doors, department stores, conference rooms, banks, offices, elevators, hospitals, exits, bathrooms, restaurants, lobbies, interior of trains and ships special 3M DI-NOC finishes are suitable for these applications.
- Outdoors: ☀️ All 3M DI-NOC™ films marked with a sun symbol.
- Wet areas such as bathrooms and indoor pools, 3M DI-NOC Architectural Finishes for Bathrooms.

Table of Contents

Primer

Primer Recommendation 3

About 3M DI-NOC™

3M DI-NOC Adhesion Characteristics..... 4
3M DI-NOC Processing Considerations 4
Effect of Overlamine on Adhesion 4
Symbols..... 4

About Walls

Wall Textures 4
Determining Type of Texture 4
Identifying Wall Composition..... 5
About Wall Texture Images 5
Inspecting and Repairing Walls 6
Common Interior Wall Problems 6
Outgassing

Application – General

Applying 3M DI-NOC to Interior Walls 6
Who Can Install 3M DI-NOC Films? 6
Tools and Supplies..... 6
Substrate Cleaning and Preparation 6
Wet or Dry Application Method?..... 7
Application Technique..... 7
Hinge Application Method..... 7
Butt Joint Method 8
Trimming Requirements 8
Finishing the Graphic Edges 8

Illustrated Application Methods

3M DI-NOC Application Procedure on 3-D Surfaces ... 9
Ceiling Application 9
Wall Paneling Application 10
Bathroom Application..... 10
Surface Patterns and Emboss Texture 10
Other Application Issues 10

Maintenance of 3M DI-NOC

Cleaning, Repair and Removal..... 10
3M DI-NOC Specifications..... 11

Miscellaneous

Warranty 11
3M Related Literature 11

3M DI-NOC Film Pre-Installation Worksheet

The Worksheet and Checklist are tools for you and your 3M sales representative to:

- summarize the type of 3M DI-NOC you will be applying.
- review and understand the key factors required for a successful 3M DI-NOC Film application.

Describe wall texture *Check only one.*

- SMOOTH: Little or no surface variation.
- UNSMOOTH TEXTURE: Has high spots and low spots.
 - Medium: Relatively equal distribution of moderately high and low spots.
 - Heavy: Irregular and severe high spots and/or low spots.
- Others: Brick, concrete block, stucco and tile.

3M DI-NOC exposure conditions

Check all that apply.

- Constant temperature and humidity
- Temperature changes
- Direct sunlight
- Heating or cooling ducts in close proximity
- People can/will be able to touch it

Wall Surface Texture vs adhesion

- A smooth surface texture provides good adhesion
- Surfaces which are porous should be treated with care, adhesion may decrease over time if the surface is not properly prepared before application.
- Too much surface texture allows the adhesive only to adhere to the high points of the texture, which does not provide sufficient adhesion for a good application.
- 3M DI-NOC laminated with a stiff overlamine, such as a slit-resistant overlamine or anti-graffiti film, cannot conform to any textures and must not be used.

Wall Surface Preparation and Painting

- Repair any existing wall damage (holes, loose wallboard joints, chipped or peeling paint) with putty to return it to like new condition.
- Use grit 100 sandpaper to smoothen the surface.
- Clean the wall prior to priming and painting.
- If necessary, paint the wall with a quality, semi gloss top coat. Do not use matte paint or paint with silicone, graffiti-resistant or texturizing additives.
- Prime the wall with a primer that is compatible with the top paint coat. Two coats may be required. Refer to 3M DI-NOC recommended primers such as Scotch mount 4297, Primer 94, WP2000, etc.
- Allow the putty and primer to dry/cure as recommended by the primer/putty manufacturer.
- Do not apply 3M DI-NOC to any wall that does not have excellent adhesion to substrate bonding. Do not apply to wallpaper.

3M DI-NOC Application

- Clean the wall immediately prior to applying 3M DI-NOC Finishes.
 - For newly painted walls, use a soft, clean, lint-free cloth to thoroughly remove all dust.
 - For existing walls, wash with 1 teaspoon of synthetic detergent per liter of lukewarm water. Avoid soaps or preparations that contain waxes, oils, lotions or conditioners. Allow to dry thoroughly (at least one hour) before proceeding.
- Use a DRY application method.
- 3M™ Plastic Applicator PA1 (white).
- Use straight overlapping strokes and use the rivetbrush and heat gun to push the 3M DI-NOC adhesive into the texture of the wall to ensure good adhesion.
- Trim 3M DI-NOC 5 mm from inner and outer wall corners.
- ALWAYS finish the graphic by working the squeegee/rivetbrush in small circles around the entire outer 5 cm of the graphic.

Primer Recommendations for 3M DI-NOC

Key to success:

Choosing and using the right primer and paint can have a significant effect on 3M DI-NOC adhesion.

The goal is to achieve a good bond between the substrate, primer and 3M DI-NOC Finishes. Primer is required at any overlap and end / edge of the film. I.e. underneath the butt joint and wherever the material is stretched.

SURFACE PREPARATION	SUBSTRATE						
	Wood Luan Veneer Chinese Veneer Hardboard	Plaster Board Calcium Silicate Board (with sealer coating) Asbestos Slate	PVC Coated Steel 3M DI-NOC applied over 3M DI-NOC	Mortar (with sealer coating)	Bonderized Steel Plate Baked Enamel Paint on Steel	Aluminum Plate Stainless Steel	Plywood, MDF board Painted or coated metals, etc.
PRIMER	Scotch mount 4297 or Primer 94	WP-2000, Scotch mount 4297 or Primer 94	Scotch mount 4297 or Primer 94		Scotch mount 4297 or Primer 94	Scotch mount 4297 or Primer 94	WP-3000
	Whole Surface			Edge or critical area of surface only			

Wait 15 - 30 minutes for drying primers before applying 3M DI-NOC. However, if the application surface temperature is below 10°C, you will need to wait 2 - 3 hours after applying primer.

Priming of 3M DI-NOC Film

	Solvent Based Primers	Water Based Primers	
	Scotch mount 4297 or Primer 94	WP-2000	WP-3000
Type		Synthetic Rubber	Synthetic Rubber
Substrate Features	Refer above	Calcium Silicate and Plaster boards	Complex surfaces only
Container Size	1 liter	4 liter	120 ml
Usage	Do not dilute	Mix with maximum 4 parts water	Mix with maximum 4 parts water
Coverage	20 – 30 sqm/l	15 – 30 sqm/l	1.2 sqm/container
Color	Slightly Yellow (will go brown if exposed to UV)	Blue	Milky
Solids	13%	48%	40%
Viscosity	4.5 m Pa.s	2400 m Pa.s	500 m Pa.s
Shelf Life	Use within 1 year of purchase	Use within 1 year of purchase	Use within 1 year of purchase

The use of primer causes a significant increase in adhesion force. Therefore repositioning of the film during application will be difficult and can even cause damage to the substrate below the primer. 3M holds no responsibility or liability in case of damage to the substrate. During pre-application inspection of the substrate this has to be taken into consideration so the proper precautions can be taken.

3M DI-NOC Adhesion Characteristics

Adhesion is the ability of the 3M DI-NOC adhesives to bond to the substrate. The amount of both initial and final adhesion varies with the type of adhesive used on the 3M DI-NOC, the substrate/surface, and the application temperature and application techniques. The bond builds with time. 3M DI-NOC may never achieve its full bond if the graphic is poorly applied or you are using the wrong 3M DI-NOC series for the substrate.

- **Final Adhesion.** The maximum bond of a 3M DI-NOC film is achieved in 24 to 48 hours after application.
- **Initial Adhesion.** The amount of bond needed to hold the graphic in place during application.
- **Size of Graphic.** The larger the 3M DI-NOC graphic, the greater the adhesive bond to the wall must be to support the weight of the graphic.

3M DI-NOC Stretching. 3M DI-NOC stretched during application may later shrink. This decreases wall adhesion and the graphic may fall off prematurely. Use primer to minimize shrinkage.

Film Processing Considerations

The common methods for processing large format 3M DI-NOC include screen printing 1900 inks and 1920 DR clear, digital printing PIJ with 3M™ 1920 DR or 3M™ 8519/8520 laminate and electrocut is possible, but not warranted (multi color production is not recommended).

Processing methods and conditions may affect the 3M DI-NOC application and performance. Always refer to the 3M DI-NOC Product Bulletin for details.

Effect of Overlaminates on Adhesion

Finished graphics must retain some flexibility in order to achieve maximum adhesion. If a laminate is required, use a transparent laminate like SC8519. Do not use a stiff or thick overlaminates on the graphic, such as 3M's Scotchgard™ Graphic and Surface Protection Film 8991.

Note: Only 3M DI-NOC with smooth surfaces can be used for printing. If the surface pattern is rough, inks will not adhere properly.

Symbols

- ☀ Suitable for outdoor use. Can be applied on PVC coated steel.
- ☀ Suitable for outdoor use. Cannot be applied on PVC coated substrates, film easily changes its color through time.
- W Material will shrink through time. Do not use butt joint method. Use overlap joints and primer when applying multiple W Series panels.
- ✳ Refer to the design pattern on another page (S-20 for SG color chart, S-22 for HG).
- ☐ ! Do not use on three-dimensional surfaces and thermoforming process.

Wall Textures

Key to success:

Understanding the type of wall texture, you have to work with helps you to select the right film for the job.

Determining Type of Texture

Texture has a significant effect on 3M DI-NOC film choice, ease of application, adherence and removal.

If the texture is too heavy, the direct application of 3M DI-NOC finishes may not be possible. Use putty and primer to smooth the surface.

Many walls consist of a *substrate* - the supporting structure - with a coating or covering such as paint, varnish, putty, wallpaper or other surface finish. That finish becomes the wall's *application surface*. For other walls, the substrate is also the wall's application surface. For example, brick, concrete block, ceramic tile or laminate may function as both a substrate and the application surface.

Every application surface has some sort of texture. The texture might be as smooth as glass or as rough as heavily textured concrete and everything in between.

Smooth textures. Little or no surface variation provides the easiest application since the 3M DI-NOC adhesive can make contact with the entire surface.

Unsmooth texture. Have high and low spots, which range from just a little texture (like fine sand paper) to heavy texture (like brick). Extra effort and more time-consuming application techniques may be required to maximize the amount of 3M DI-NOC adhesion to the wall.

- **Medium.** Relatively equal distribution of moderately high and low spots.
- **Heavy.** Irregular and severe high spots and/or low spots.

- **Other.** Brick, concrete block, stucco and tile.

Identifying Wall Composition

Brick. A kiln-dried, hard clay surfacing material, thicker than tile, for interior or exterior walls. Inherently smooth, but may be patterned or textured before firing.

Painted wallboard. Common interior wall surface, primed, painted and thoroughly dried. The texture varies depending on the paint technique used.

We recommend gypsum board finish level five wallboard, which is described in the National Gypsum Construction Guide, 9th Edition, Rev 8/04, page 121. This product has the highest quality finish. A primer and final coating (such as putty) is recommended. When using 3M DI-NOC films final coating should be semi-gloss or enamel paint only.

Concrete. A building material made from a mixture of Portland cement, water, fine and coarse particles. Texture can range from smooth to heavy.

CMU (Concrete masonry/concrete block). A usually hollow building block made with concrete. May be painted or unpainted. Texture is usually medium.

Stucco. A cement or plaster mixture that is hand or machine applied to interior or exterior walls. Our example is between smooth and medium texture, although texture can range from smooth to heavy.

Tile. A kiln-dried, thin, hard clay surfacing material for interior or exterior walls. May be glazed or unglazed. Surface is usually smooth.

Vinyl wall covering. A thin to heavy weight vinyl material used to cover interior walls. Texture can range from smooth to heavy. These materials may contain plasticizers that migrate to the surface and can cause premature adhesion failure for a graphic applied over it.

About the Images on the right side of this page

Use the above descriptions and the images on the right side of this page to determine both the texture and wall composition of common interior wall surfaces. These characteristics are important in selecting the right film as well as determining if the wall is suitable for a successful 3M DI-NOC application.

Smooth Concrete

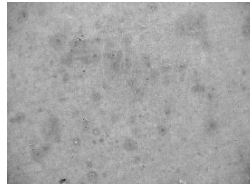

Medium Concrete

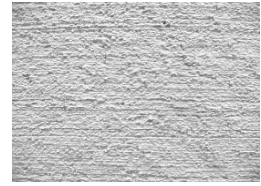

Smooth Vinyl Wallcovering

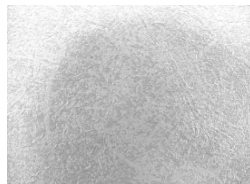

Medium Vinyl Wallcovering



Smooth Painted Wallboard

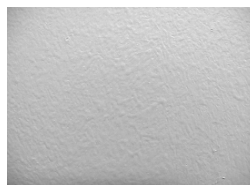

Medium Painted Wallboard

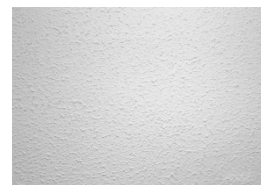

Heavy Concrete

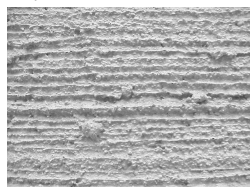

Other - Tile Glazed



Heavy Vinyl Wallcovering



Other - CMU/Concrete Block Painted and Unpainted

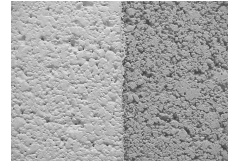

Heavy Painted Wallboard



Other - Brick



Other - Stucco



Inspecting and Repairing Walls

Key to success:

Inspecting and repairing walls before you apply the 3M DI-NOC films eases installation and helps ensure good removal.

Common Interior Wall Problems

Each of the following problems can contribute to poor 3M DI-NOC adhesion and damage during 3M DI-NOC removal if the problem is not repaired or considered prior to 3M DI-NOC application:

- Too highly textured paint.
- Poor initial paint bond.
- Poorly painted wall edges.
- Patched areas that have not been primed.
- Moisture behind the wallboard, which can cause the 3M DI-NOC adhesive to release. Watch for walls that back up to cooling systems, water pipes, overhead windows or water pipes that could drip on the graphic and boarded up windows. These areas are subject to condensation that may not be obvious at the time of installation.
- Dust, dirt or vehicle exhausts contamination on the wall.
- Vinyl wall covering as a substrate: always test the surface for acceptable adhesion characteristics.
- Contamination by other products on the wall that was not properly cleaned.

About Outgassing

As a wall finish dries, it releases certain gases until it is fully dried and cured. Applying a 3M DI-NOC film before the finish has cured can result in lifting, bubbles and premature graphic failure.

Air Quality Regulations

State Volatile Organic Compound (VOC) regulations may prohibit the use of certain cleaning solutions or primers. You should check with your State environmental authorities to determine whether use of this solution is restricted or prohibited.

Applying 3M DI-NOC to Interior Walls

Key to success:

Read all instructions before you start: this application may be different from what you have done before.

Who Can Install 3M DI-NOC Films?

A non-professional installer may install poster-size graphics with ease. Larger 3M DI-NOC graphics can be more difficult to handle and align, and multi-panel graphics require skill that is acquired only in practice. Therefore, we recommend contacting a professional graphics installer for assistance with larger 3M DI-NOC graphics.

Tools and Supplies

- Putty
- Scotch™ Masking Tape
- 3M™ Plastic Applicator PA-1 (Gold*/White*)
- 3M™ Surface Preparation System*
- Cutter for liner
- Ruler (minimum of 1 meter)
- Measuring tape
- 3M™ Air Release Tool 391X
- Band Paper
- Cutting tools, such as a razor blade with a safety holder
- Primer and brush
- Industrial heat gun; must be capable of attaining 260°C to 399°C, or equivalent

*Available from 3M Commercial Graphics Division

Substrate Cleaning and Preparation

Clean the substrate immediately before applying 3M DI-NOC finishes. Dust and other contaminants can collect quickly on the substrate and prevent the film from adhering properly. Use a clean lint-free cloth.

If the substrate has any contaminants e.g. dust, dirt, grease, loose paint, etc., the 3M DI-NOC film will not stick to it.

Pay extra attention to cleaning wall edges and corners.

For interior walls where grease and/or oil are present on the substrate: Wash the substrate with a solution of detergent and lukewarm water. After drying, use 3M™ Surface Preparation System.

For most other surfaces: Wash the substrate with detergent and lukewarm water. Avoid soaps or preparations that contain waxes, oils or lotions. Some window cleaners contain waxes.

Smooth poured concrete walls or concrete block walls may require power washing or hand washing with a stiff brush and a detergent cleaner followed by a clean water rinse to remove grease and/or exhaust contaminants. Allow the surface to dry thoroughly (at least 24 hours) before applying the 3M DI-NOC.

Dry Application Method only

All 3M DI-NOC films must be applied using a dry application method since 3M DI-NOC adhesive is Comply™ based.

Recommended Application Temperature Range

12°C – 38°C preferred

Plan Your Layout

To minimize application problems, which waste time, test your layout by temporarily positioning the graphic on the substrate using masking tape.

Overlap Application

Apply primer to the 3M DI-NOC film that will be overlapped. Wait until the Primer is completely dry before applying the next section of film.

Depending on the surface pattern and emboss texture, overlapping may prove to be difficult (e.g. Wiping Wood grain series). Use heat gun and squeegee pressure on edges to adhere the adhesive properly. For assistance, please contact 3M Architectural Market Department Technical Service.

Application Tape

For premask/prespace use 3M™ SCPS-100 application tapes. For electrocut 3M™ SCPS-55 is recommended.

Edge Sealer

If edge sealer is necessary, use 3M™ Scotchcal™ 3950 edge sealer.

Applying a Large Graphic

Center Hinged Method

1. Position the 3M DI-NOC graphic, using strips of Scotch™ Masking Tape to hold the graphic to the substrate. Then, apply a strip of masking tape 5.1 cm - 7.5 cm wide, horizontally across the top of the graphic. See Figure 1.
2. Fold half of the 3M DI-NOC graphic back over the hinge. Peel off the liner all the way to the tape hinge. Then cut just the liner along the hinge. Discard the liner. See Figure 1.
3. Fold the graphic back onto the substrate.

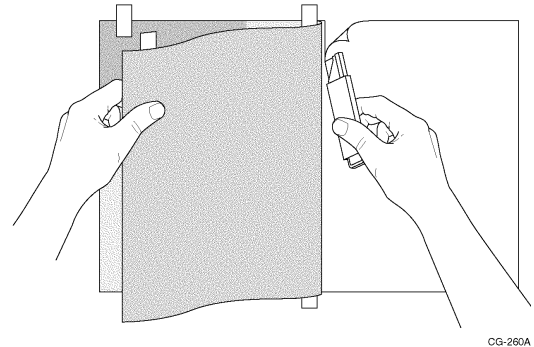

CG-260A

Figure 1. Remove Liner with Center Hinged Method

4. Hold the 3M DI-NOC graphic away from the surface with one hand. Allow the adhesive to touch the substrate as pressure is applied during squeegeeing. Squeegee the graphic beginning at the center of the tape hinge and working outward to the closest edge. See Figure 2. Use firm pressure on the plastic applicator and overlap the strokes.
5. Remove the tape.
6. Apply the other half of the graphic in the same manner.
7. Complete the application by re-squeegeeing the edges.

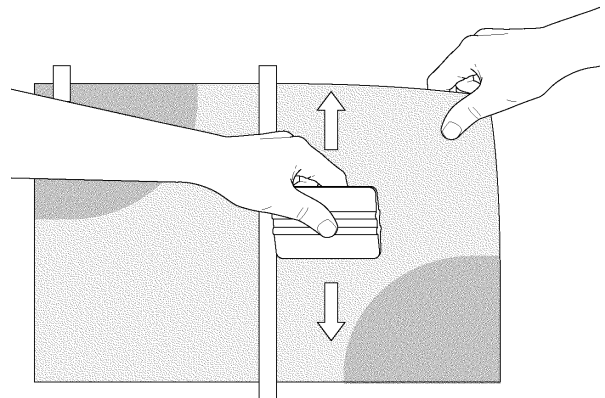

CG-261A

Figure 2. Squeegee a Center Hinged Graphic

Butt Joint Application Method

Whenever two or more panels of the same color of 3M DI-NOC film are seamed together they should be matched to assure uniform daytime color and transmitted night appearance.

Material from a single roll or lot must be used on a single marking or sign for identical color matching.

- Butt joint is used only when visibility is important
- Prime 5 cm of the substrate on the butt joint area to avoid any shrinkage on butt joint area over years
- Leave 5 cm of liner on panel 1
- Apply panel 1
- Apply panel 2 overlapping panel 1 by 3 – 5 cm
- Use a straight edge to cut through both panels on the overlap area
- Remove liner and excess film
- Apply film to form a butt joint

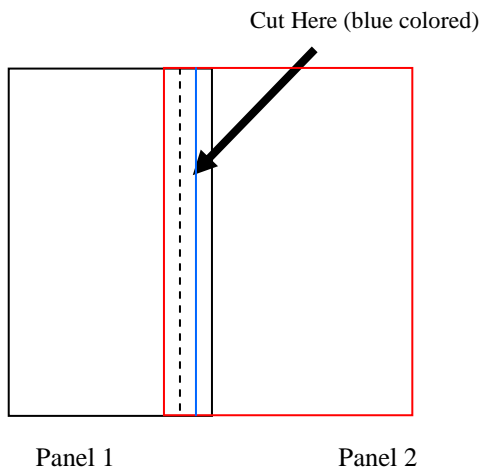

Note: Butt joint is not recommended for three-dimensional surfaces and curved areas. Use overlap for it.

Trimming Requirements

Certain areas of your graphic applications are more subject to damage than others from people or equipment rubbing against the edges. This includes areas around doors, openings such as vents, outside corners of walls and inside corners. To reduce the risk of damage and lifting, trim the 3M DI-NOC from the edge. After application, re-squeegee all edges of the graphic to help ensure good edge adhesion.

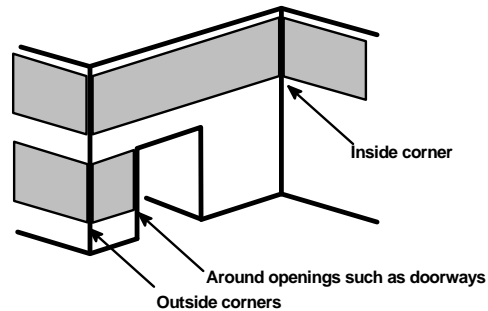

Finishing the Graphic Edges

Usually, the area with the least adhesive bond is the outer few cm of the graphic. Always re-squeegee the edges in small circular movements before you consider the job done. Use a heat gun at 70°C. Always grasp the film as far into graphic as possible without wrinkling the film to avoid transferring body oil and dirt to the adhesive, which can cause adhesion problems. To avoid the problem calculate 5 – 10 cm more material on all edges.

3M DI-NOC Application Procedure Three-Dimensional Curved Surface

- D When applying to a non-circular 3D surface, apply firstly at the corners, then along the straight edges in the sequence: a, then b & c, then d & e, etc.

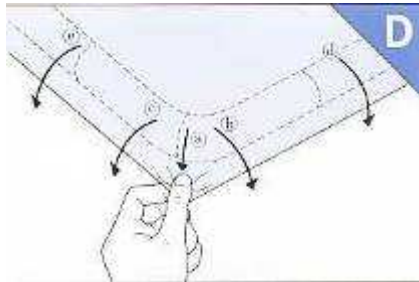

- E Prime the rear surface (approx. 5 cm in from the edge) and extend the 3M DI-NOC application 2 – 5 cm onto the rear surface. This secures the product and prevents it from shrinking.

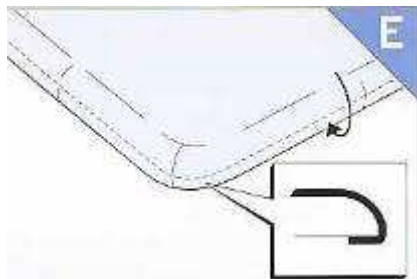

- F Trim off any excess 3M DI-NOC on the rear surface and apply a tab/strip of 3M DI-NOC to the cut edge (in particular, the corners), to further stabilize the application and prevent shrinkage.

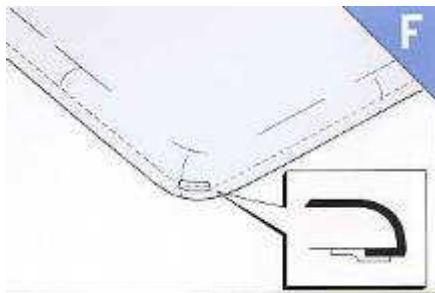

Installation explanation

Apply film to the protruding metal corner extrusion

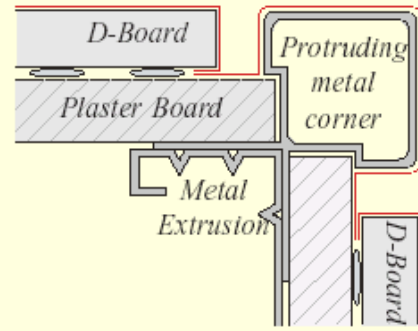

Installation Example

Screw the decorative molding to hold the film down.

The decorative molding is a feature and also hides the film seams.

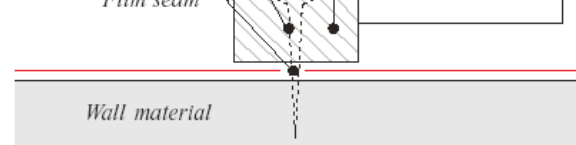

Ceiling Application

Installation Details

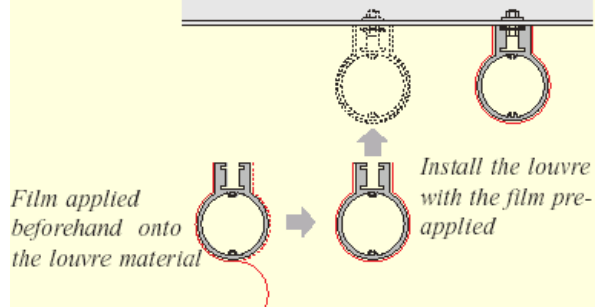
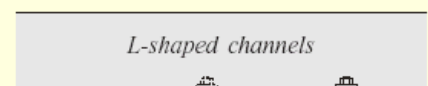

Installation Details

Apply the film into the recess between the wall panels

Fix the insert strip so that it protrudes slightly

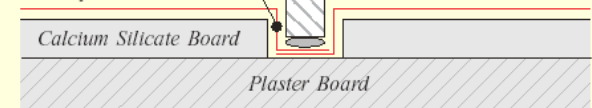

Installation Details

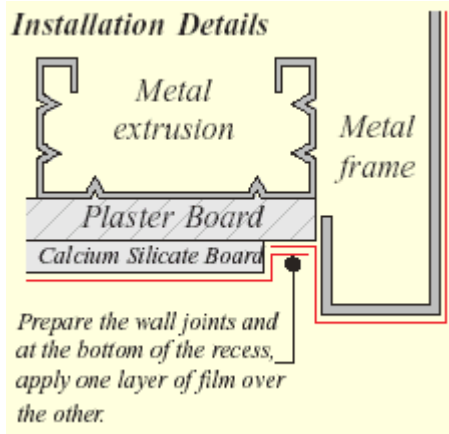

Wall Paneling Application

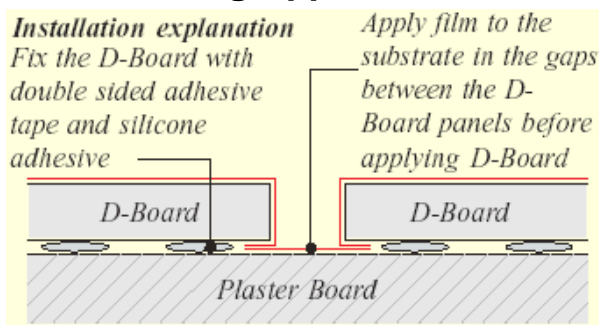

Bathroom Application

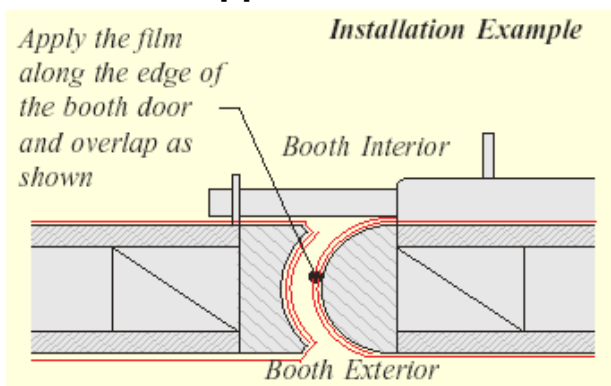

Surface Patterns and Emboss Textures

When cutting 3M DI-NOC films or applying panels of the same design side by side, adjoining panels may contrast significantly in color. Make sure that material for adjoining panels is applied in the same roll direction and from the same production lot. In addition, there are very subtle changes in grain pattern in the embossed surfaces of the films. Check on the grain direction before applying adjoining panels to minimize any color shift or gloss change between the panels.

Other Application Issues

1. Avoid applying the materials in locations that face direct sunlight and are surrounded by glass. Increased temperature may cause damage to the glass.
2. You may occasionally see a splice in a roll.
3. Please consider the color of the application surface before applying 3M DI-NOC films. Highly colored substrates can cause a slight color shift in some 3M DI-NOC films. A test application should be performed and the result approved by the customer, if the films must be applied to a highly colored surface.

Cleaning 3M DI-NOC Film

1. Use commercially available synthetic detergent. Avoid using organic solvents or strong detergents that are either highly alkaline (pH>11) or acid (pH<3). Check with us for 3M Cleaners that are compatible with 3M DI-NOC.
2. Use a soft cloth or cleaning sponge. Do not use sponges or cleaning cloths that contain abrasive materials.
3. Moisture that has penetrated wallboard will destroy the application surface when graphics are removed. Remember that, especially in remodeling jobs, wallboard may have been placed over windows, cooling pipes, etc., that may produce moisture that is transferred to the wallboard.

Removal of 3M DI-NOC Film

3M DI-NOC films are not designed with removal in mind, as the combination of film adhesive and primer ensure a very high bond to most surfaces. We recommend applying new material on top of existing 3M DI-NOC, instead of removal. However, if 3M DI-NOC must be removed, the following method can be attempted.

1. Make cuts about 20 cm apart in the 3M DI-NOC film, making sure not to damage the substrate.
2. Use a heat gun to warm at 80°C to soften the 3M DI-NOC film.

3. Remove the strips of film.
4. If adhesive remains on the substrate, remove it using 3M™ Adhesive Remover System R-231, or similar solvent.

Note: Test that the solvent will not damage the substrate before beginning removal.

3M DI-NOC Specifications

Construction: polyvinyl chloride film with permanent adhesive

Application Environment: Minimum application temperature 12°C

Recommended Application Temperature: 16°C – 38°C (20°C – 25°C preferred)

Storage Conditions

Store film in a clean, dry environment, free from direct sunlight and at an ambient temperature below 38°C. The combined shelf life as processed and unprocessed film cannot exceed 1 year from the date you receive the film. However, the film must be used within 1 year of purchase.

Warranty

The information contained and techniques described herein are believed to be reliable, but 3M makes no warranties, express or implied, including but not limited to any implied warranty of merchantability or fitness for a particular purpose. 3M shall not be liable for any loss or damages, whether direct, indirect, special, incidental or consequential, in any way related to the techniques or information described herein.

3M Related Literature

Before starting any job, be sure you have the most recent product and instruction bulletins.

The following bulletins provide the information you need to properly use the 3M products that may be used in your graphic. You can find these bulletins on our Web site at:

www.3M.eu/ArchitecturalMarkets

For Further Assistance

For help on specific questions relating to 3M Commercial Graphics products, please contact your local 3M Technical Service person or contact:

3M Deutschland GmbH

Display & Graphics Laboratory

Carl-Schurz-Straße 1

D-41453 Neuss

Germany

Internet: www.3M.eu/ArchitecturalMarkets

The use of trademark signs and brand names in this bulletin is based upon US standards. These standards may vary from country to country outside the USA.